

MAQUESINA DE SEGURIDAD

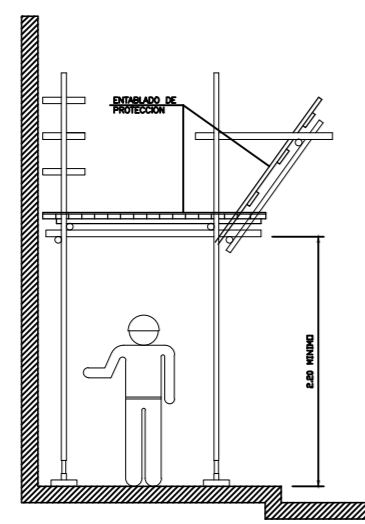

PASILLO DE SEGURIDAD

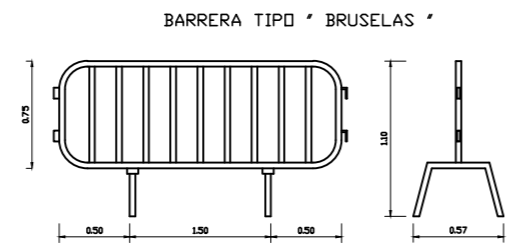

BARRERA TIPO "BRUSELAS"

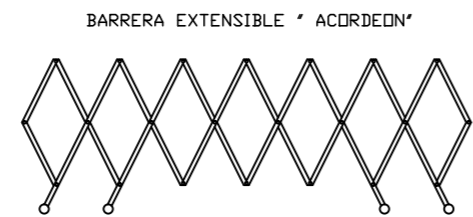

BARRERA EXTENSIBLE "ACORDEON"

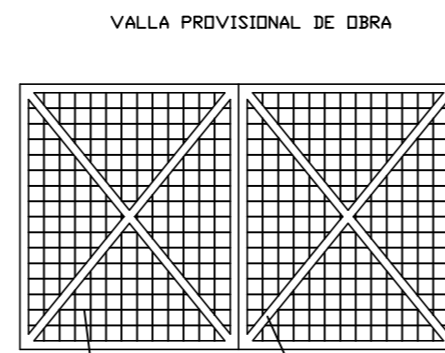

VALLA PROVISIONAL DE OBRA

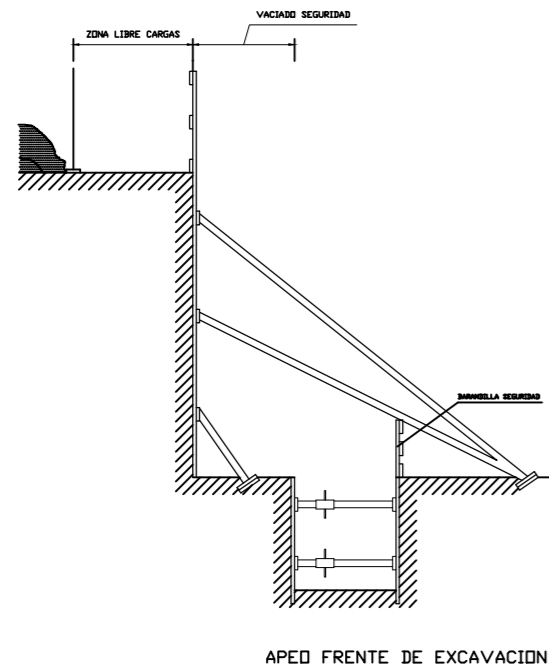
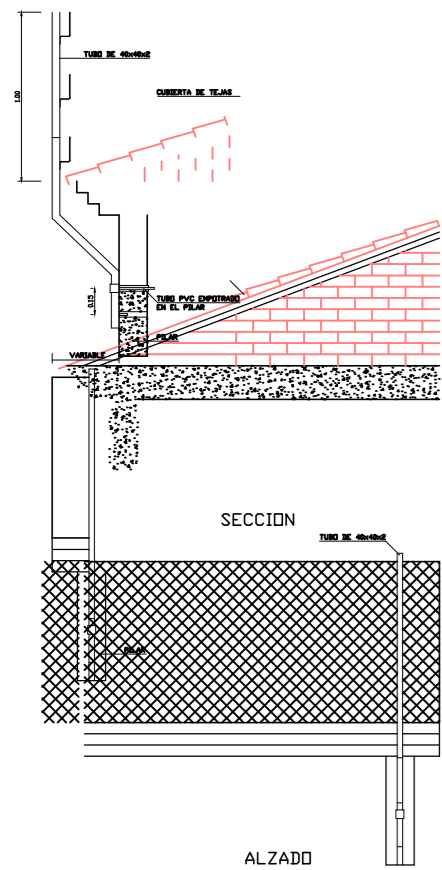
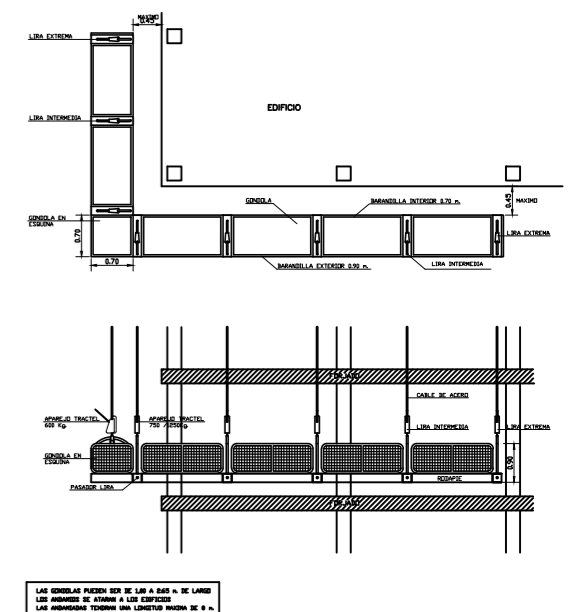
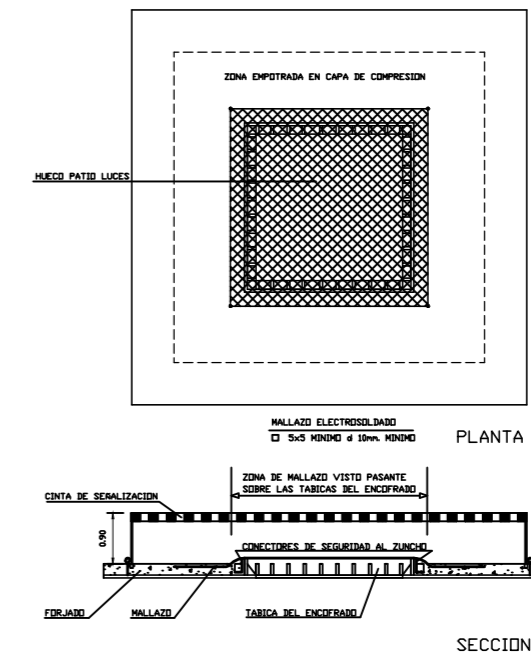
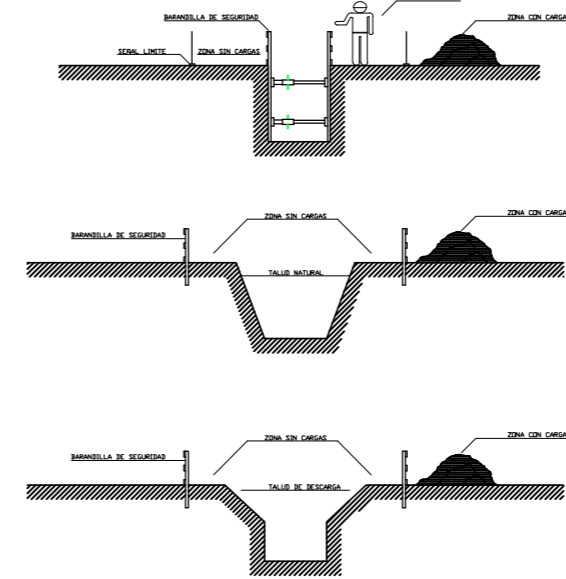

APEO FRENTE DE EXCAVACION

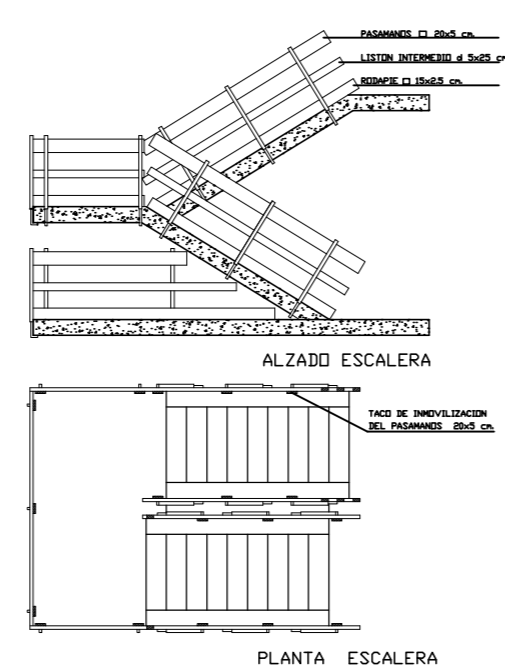

PLANTA ESCALERA

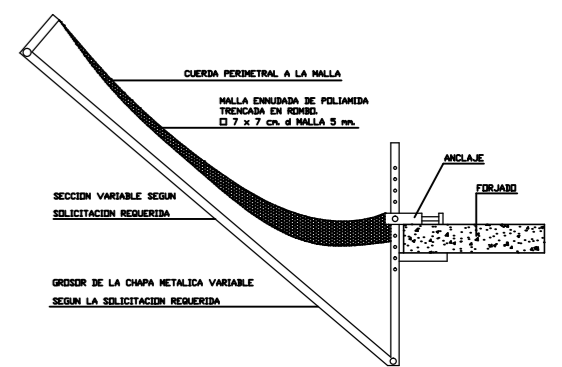
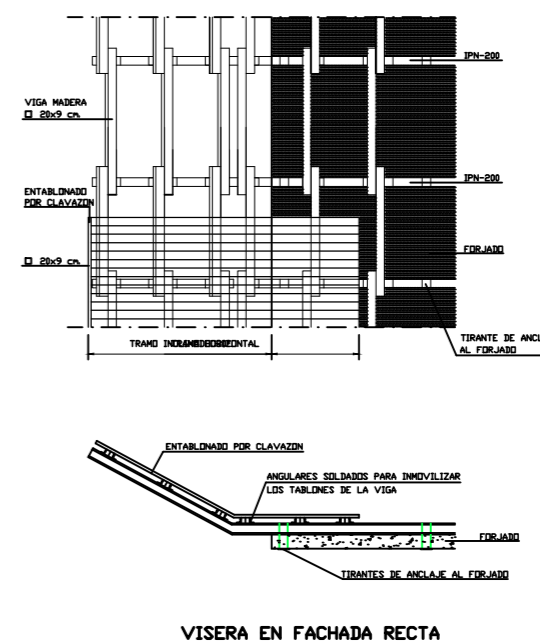
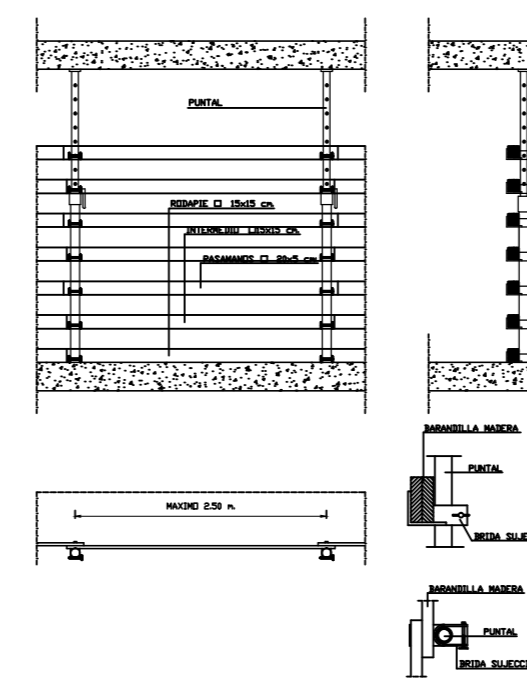
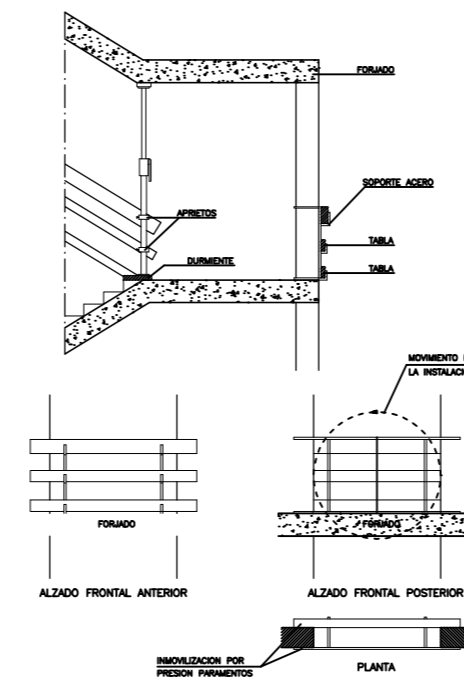

HORCON SIMPLE MARCA ALBO

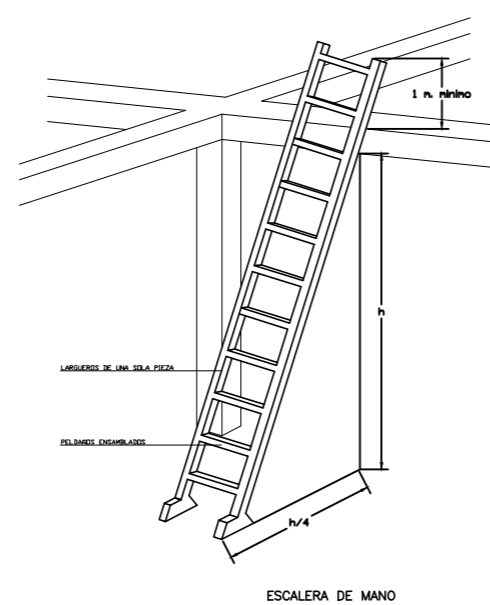
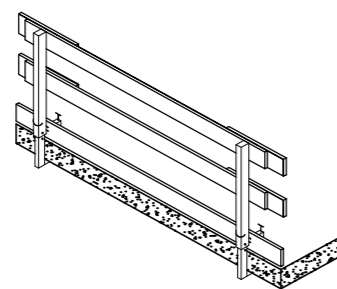
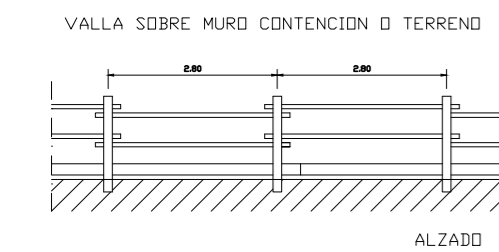

ESCALERA DE MANO

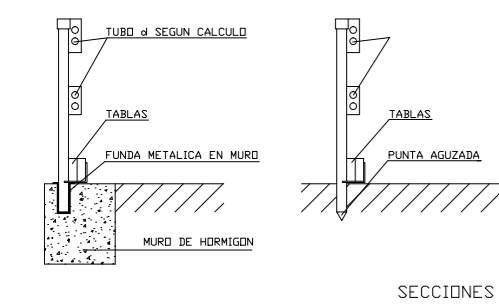
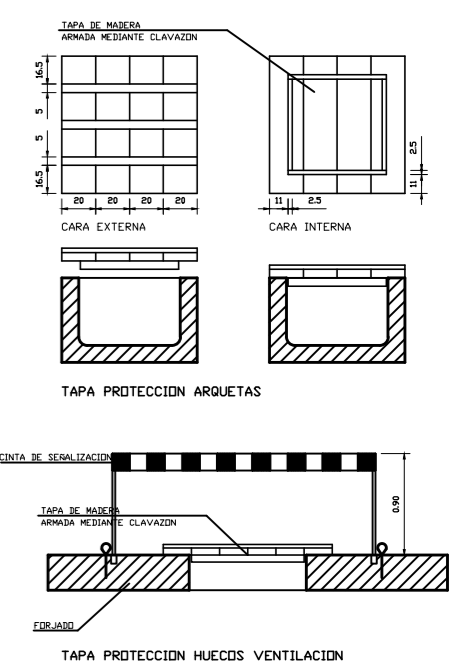
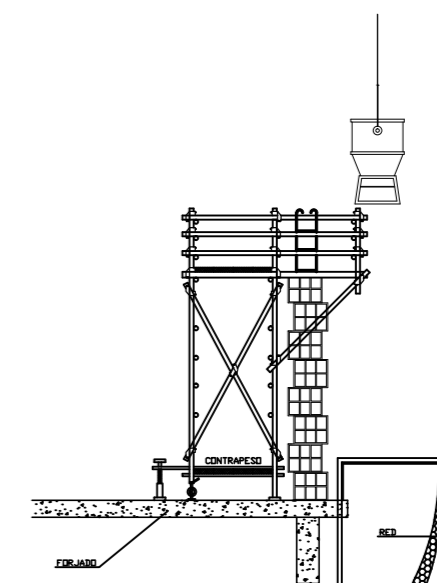
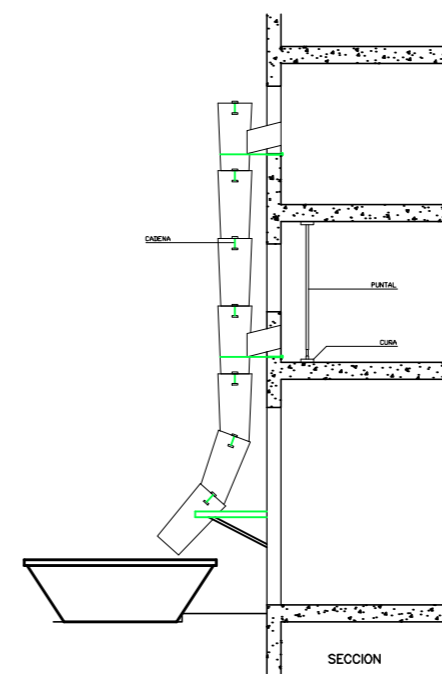
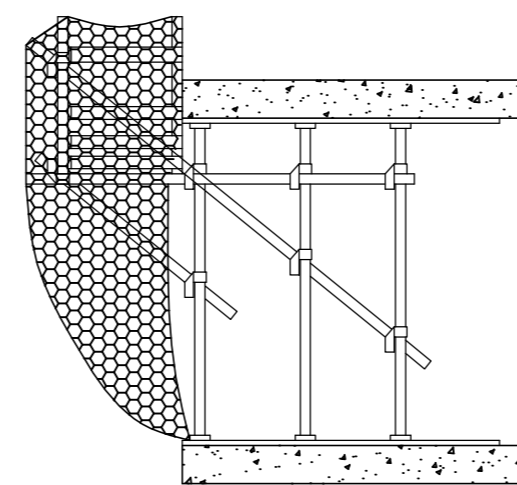

SECCIONES

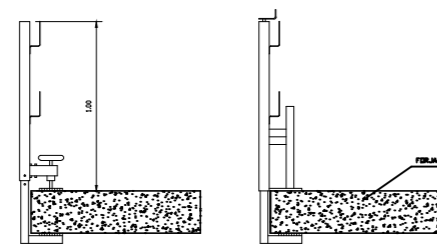

BARANDILLA TIPO "SARGENTO"

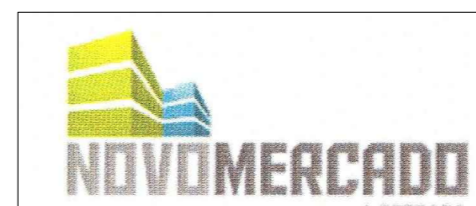

AYUNTAMIENTO DE A ESTRADA.
A ESTRADA 36680. PONTEVEDRA.
ESTUDIO DE SEGURIDAD Y SALUD
NOVO MERCADO, CENTRO DE DIA Y LUDOTECA.

JUAN CARLOS PICÁNS VILLAR
Arquitecto: nº coleg. 1970

nº Plano:

Situación: RUA WALDO INSUA Nº 00 - A ESTRADA. PONTEVEDRA.

Fecha: AGOSTO 2012 Referencia: Escala: 1/

Plano: DETALLES

E03